

## Lavello Quadra EVO



Lavelli in acciaio inox

Codice: 1257 050



### CARATTERISTICHE

#### FONDO STAMPATO

Il fondo stampato garantisce il perfetto deflusso dell'acqua e facilita le operazioni di pulizia grazie al gradino perimetrale con le pareti inclinate.

#### LAVELLI DI SPESSORE

Acciaio spesso 1 mm. Uno spessore importante che garantisce la massima robustezza per lavelli che non conoscono i segni del tempo.

#### PILETTA 3,5" BASKET

Lo scarico è dotato di piletta grande 3,5", con il pratico tappo a cestello che impedisce il defluire nello scarico di parti solide.

#### TROPPO PIENO PERIMETRALE

Il troppo/pieno è una sicurezza sempre presente sui lavelli Foster che impedisce il traboccare dell'acqua dalla vasca in caso di dimenticanze. La soluzione a scarico perimetrale migliora l'estetica grazie alla forma squadrata ed essenziale.

#### VASCA PROFONDA

Vasche che raggiungono una profondità importante, oltre i 20 cm, grazie alla evoluta tecnologia produttiva, che offrono grande capienza e praticità in tutte le operazioni di lavaggio.

#### VASCA QUADRA - RAGGIO 0

Le vasche quadre di Foster hanno gli spigoli verticali perfettamente squadrati.

### DETTAGLI

Bordo Installazione

Sopratop | Filotop

Finitura Spazzolato Foster

---

Materiale Acciaio inox AISI 304

---

Texture Spazzolatura in linea

---

Base 80 cm

---

Dimensioni 780 x 470 mm

---

Dotazioni standard Ganci di fissaggio, guarnizione, piletta, troppo-pieno e sifone, Imballo in scatola

---

Fori Mixer Nessun foro di serie

---

Foro incasso Vedi scheda tecnica

---

Gocciolatoio No

---

Larghezza 78 cm

---

Misura vasca 740x430 mm

---

Numero vasche 1 vasca

---

Piletta Piletta 3,5"

---

## IN DOTAZIONE

1 x Griglia Black 8100 614  
1 x Griglia Black 8100 615

## DATI TECNICI

**1257/05-**

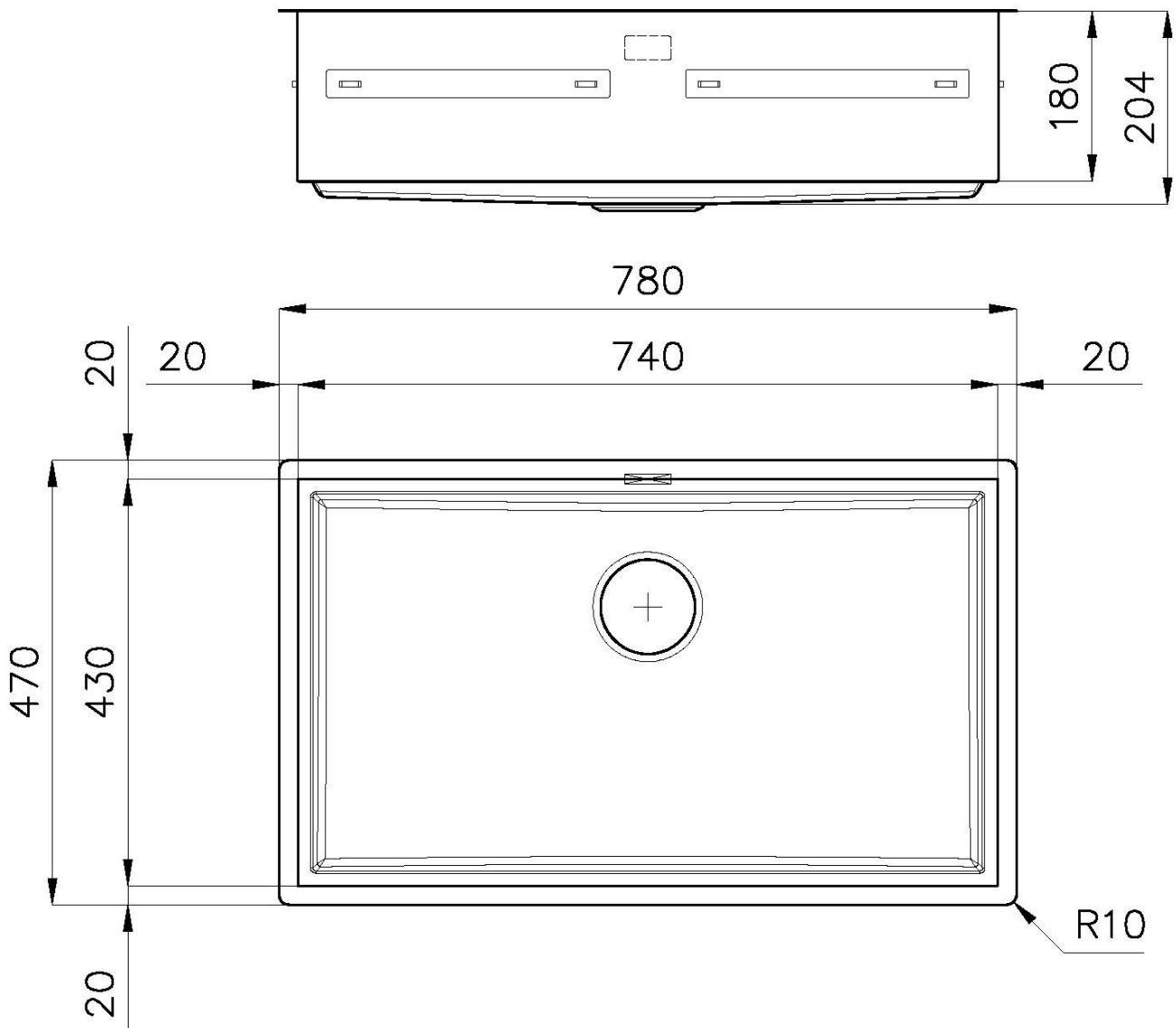

## **QUADRA EVO** **Optional accessories / Accessori opzionali** **FILOTOP / FLUSHMOUNT**

### **LEVEL 1:**

**8100 615**

**8100 614**

**8100 037**

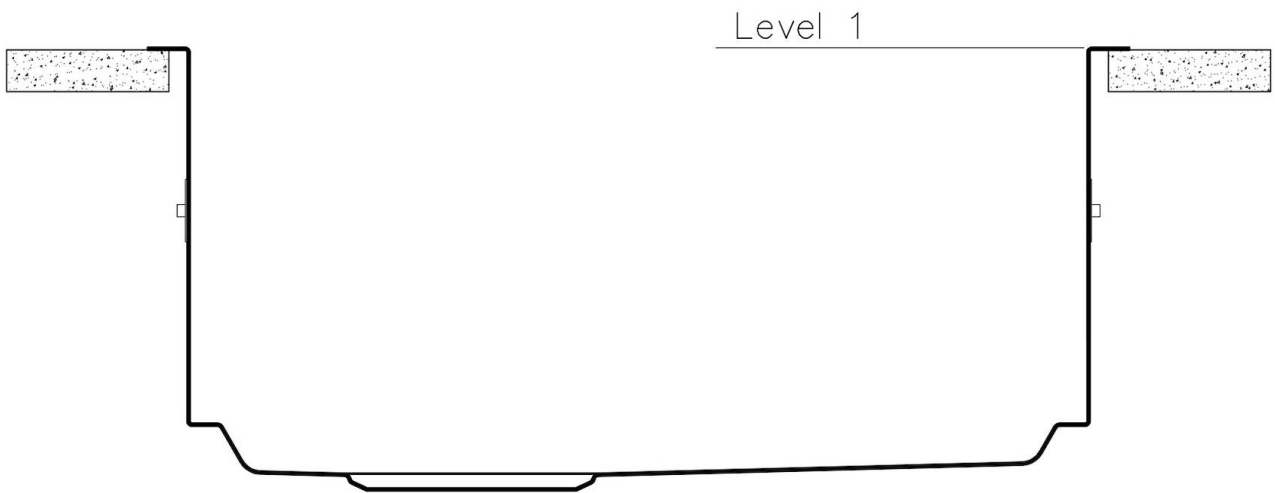

**QUADRA EVO**  
**Optional accessories / Accessori opzionali**  
**FILOTOP / FLUSHMOUNT**

**LEVEL 2:**

**8100 615**

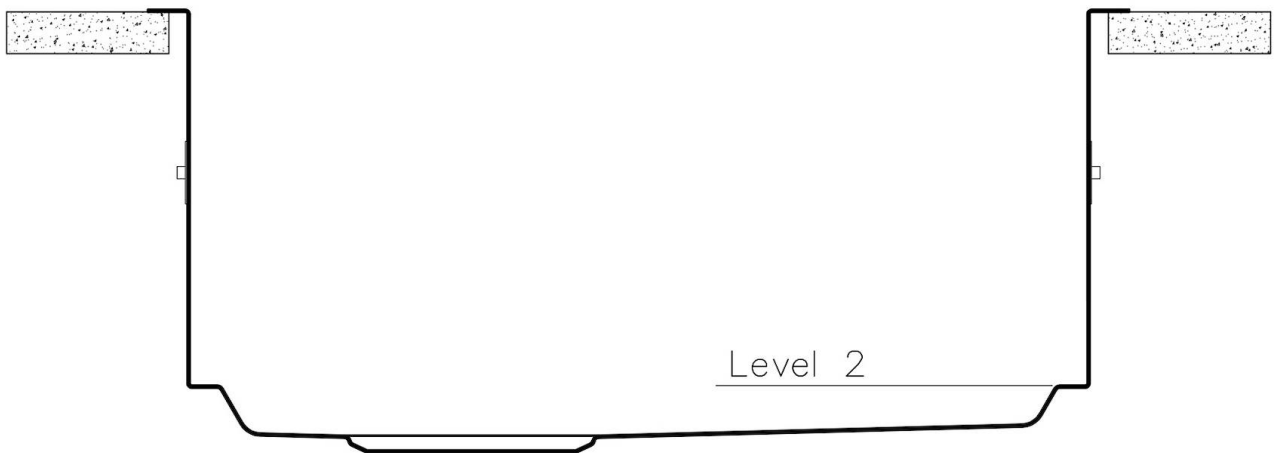

**1257/05-**

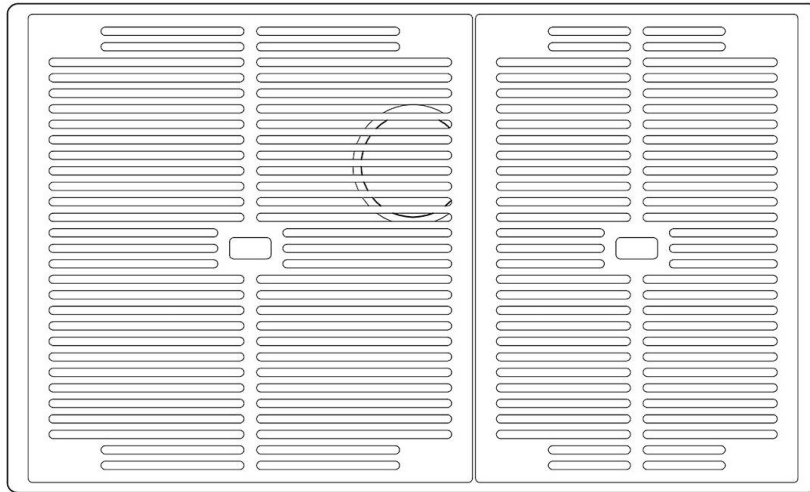

**8100 615 + 8100 614**  
**POSIZIONATE A FILO VASCA / EDGE POSITIONING**

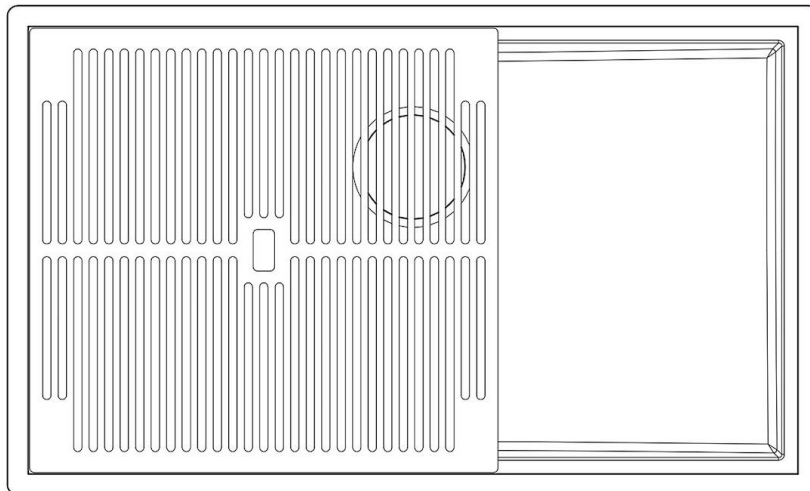

**8100 615**  
**POSIZIONATA SUL FONDO / BOTTOM POSITIONING**

1257/05-

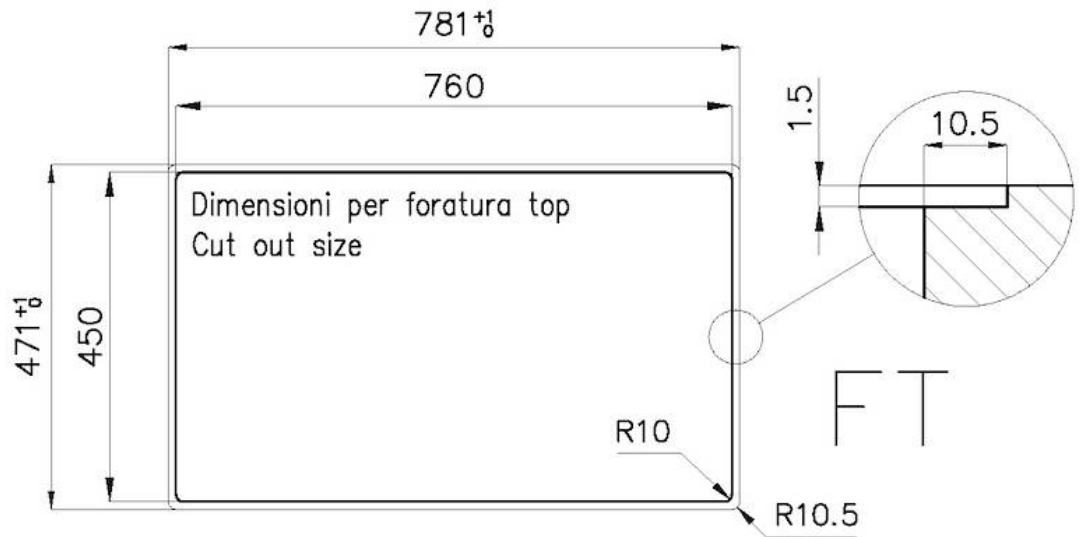

intaglio per il troppo-pieno  
solo con top > 10 mm  
recess for housing the over-flow  
only for top > 10 mm

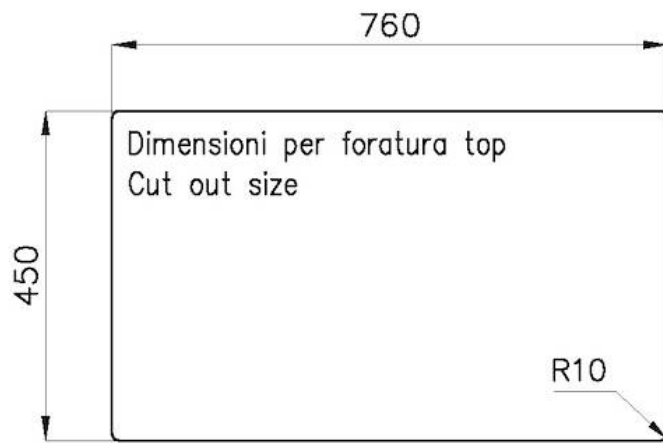
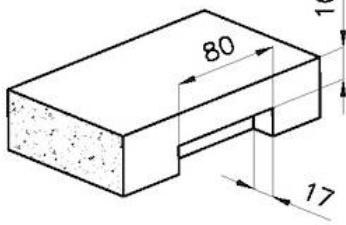

## GALLERIA FOTOGRAFICA

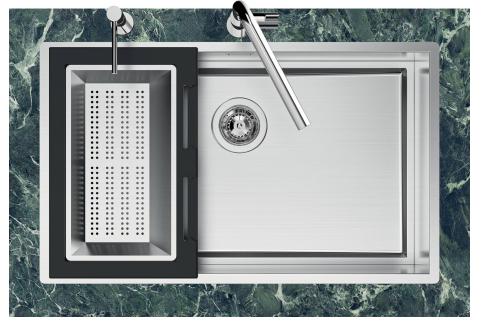
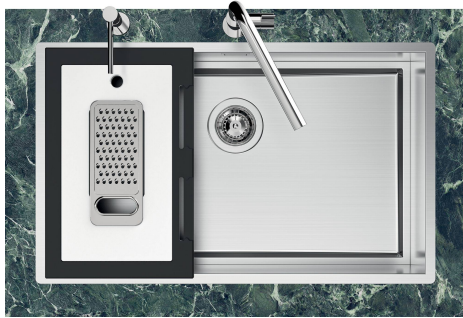
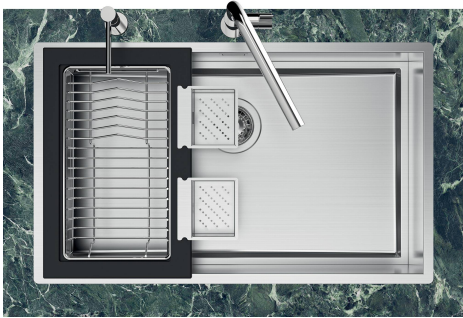
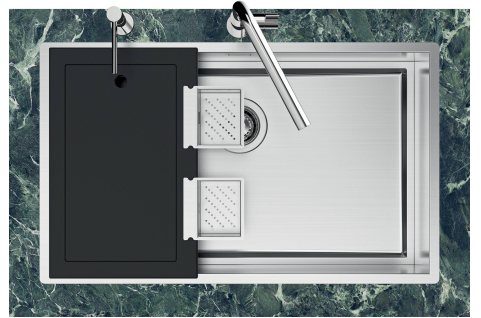
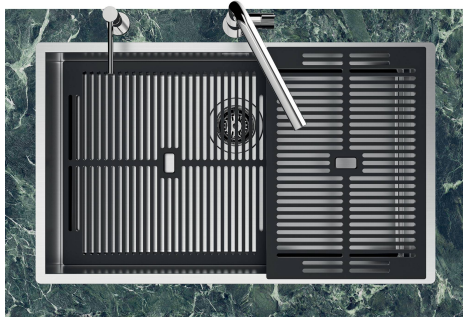
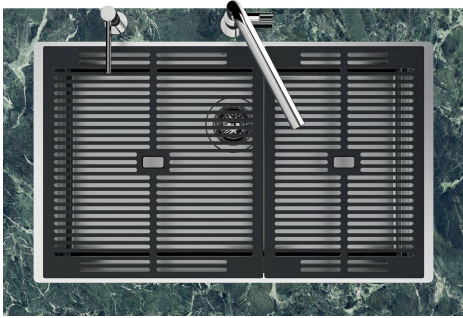

## IN DOTAZIONE



**Griglia Black**  
8100 615



**Griglia Black**  
8100 614



## ACCESSORI OPZIONALI

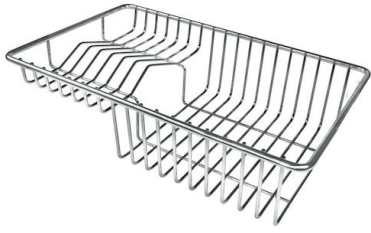

**Cestello portapiatti inox**  
8100 303



**Vaschetta bianca**  
8153 100



**Vaschetta forata inox**  
8151 001



**Kit Black**  
8100 037



**Kit grattugia con supporto per  
anello e vassoio di raccolta alimenti**  
8159 101



**Vaschetta forata inox**  
8151 000



**Vaschetta forata inox PVD Copper**  
8151 008



**Vaschetta forata inox PVD Gold**  
8151 009



**Vaschetta forata inox PVD Gun  
Metal**  
8151 006

## PILETTE AUTOMATICHE OPZIONALI



**Piletta automatica PM**  
8407 113



**Piletta automatica Space Light PL**  
8407 117



**Piletta automatica Space Push PP**  
8407 116



**Piletta automatica Space PA**  
8407 108